

## Product Summary

The GESDN15VD31 is designed to protect voltage sensitive electronic components from ESD and other transients. Excellent clamping capability, low leakage, low capacitance, and fast response time provide best in class protection on designs that are exposed to ESD.

The combination of small size, low capacitance, and high level of ESD protection makes them a flexible solution for applications such as HDMI, Display Port TM, and MDDI interfaces. It is designed to replace multiplayer varistors (MLV) in consumer equipments applications such as mobile phone, notebook, PAD, STB, LCD TV etc.

## Feature

- Low reverse stand-off voltage:15V
- Low reverse clamping voltage
- Ultra-low leakage current
- Fast response time
- IEC 61000-4-2 Level 4 ESD protection

## Application

- Computers and peripherals
- Power lines
- Audio and video equipment
- Cellular handsets and accessories
- Portable electronics
- Other electronics equipments communication systems

## Marking:

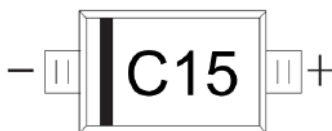

Front Side  
C15=Device Code

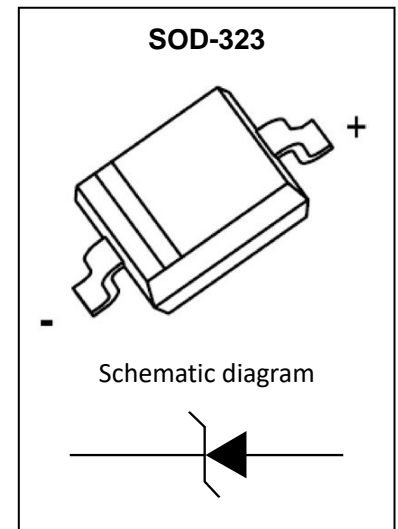

## Absolute Maximum Ratings ( $T_A=25^{\circ}\text{C}$ unless otherwise noted)

Parameter	Symbol	Value	Unit
IEC 61000-4-2 ESD Voltage Air Model	$V_{\text{ESD}}$	$\pm 16$	kV
IEC 61000-4-2 ESD Voltage Contact Model		$\pm 16$	
JESD22-A114-B ESD Voltage Per Human Body Model		$\pm 8$	
ESD Voltage Machine Model		$\pm 0.4$	
Peak Pulse Power (8/20 $\mu\text{s}$ )	$P_{\text{pk}}$	240	W
Peak Pulse Current (8/20 $\mu\text{s}$ )	$I_{\text{PP}}$	6	A
Junction Temperature	$T_{\text{J}}$	-55~ +125	$^{\circ}\text{C}$
Storage Temperature	$T_{\text{stg}}$	-55~ +150	$^{\circ}\text{C}$

## ESD standards compliance

### IEC61000-4-2 Standard

Contact Discharge		Air Discharge	
Level	Test Voltage kV	Level	Test Voltage kV
1	2	1	2
2	4	2	4
3	6	3	8
4	8	4	15

### JESD22-A114-B Standard

ESD Class	Human Body Discharge V
0	0~249
1A	250~499
1B	500~999
1C	1000~1999
2	2000~3999
3A	4000~7999
3B	8000~15999

### Contact discharge current waveform per IEC61000-4-2

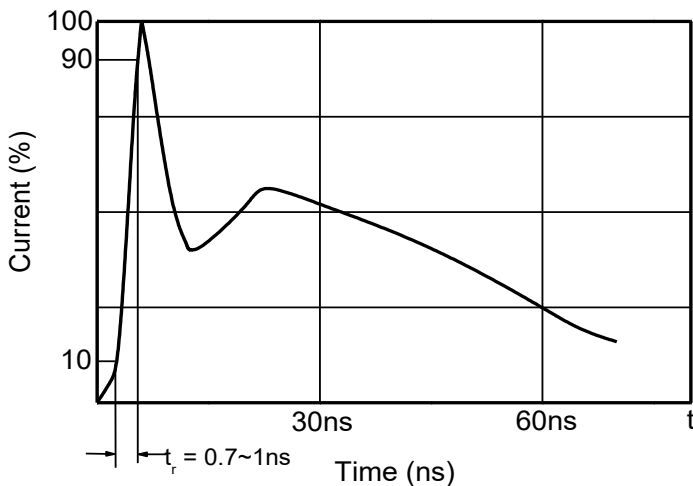

### 8/20 $\mu\text{s}$ waveform per IEC61000-4-5

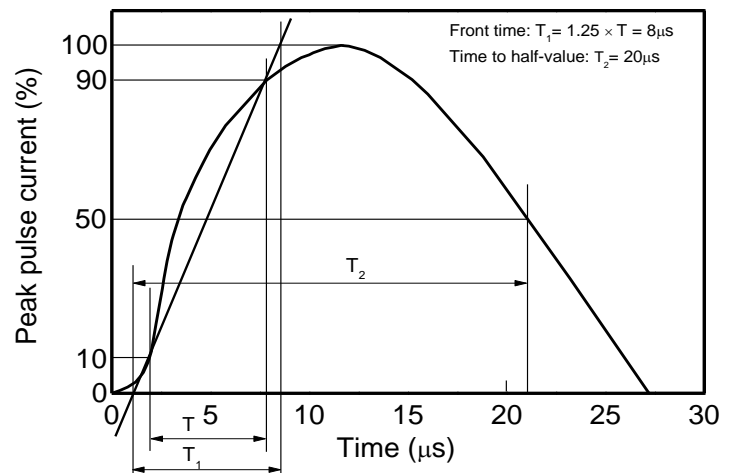

## Electrical Parameter

Symbol	Parameter
V <sub>C</sub>	Clamping Voltage @ I <sub>PP</sub>
I <sub>PP</sub>	Peak Pulse Current
V <sub>BR</sub>	Breakdown Voltage @ I <sub>T</sub>
I <sub>T</sub>	Test Current
I <sub>R</sub>	Reverse Leakage Current @ V <sub>RWM</sub>
V <sub>RWM</sub>	Reverse Standoff Voltage

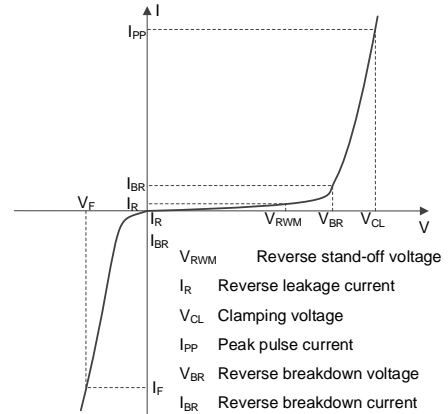

V-I characteristics for a Uni-directional TVS

## Electrical Characteristics ( $T_A=25^\circ\text{C}$ unless otherwise specified)

Parameter	Symbol	Test conditions	Min	Typ	Max	Unit
Reverse stand-off voltage	$V_{RWM}^{(1)}$				15	V
Reverse leakage current	$I_R$	$V_{RWM}=15\text{V}$			1	$\mu\text{A}$
Forward voltage	$V_F$	$I_F=10\text{mA}$			0.9	V
Breakdown voltage	$V_{BR}$	$I_T=1\text{mA}$	16.7		21	V
Clamping voltage	$V_C^{(2)}$	$I_{PP} = 6\text{A}$		29	40	V
Junction capacitance	$C_J$	$V_R=0\text{V}, f=1\text{MHz}$		50	100	pF

- 1) Other voltages available upon request.
- 2) Non-repetitive current pulse 8/20 $\mu\text{s}$  exponential decay waveform according to IEC61000-4-5

**Typical Characteristics**

**$V_C$  vs.  $I_{PP}$**

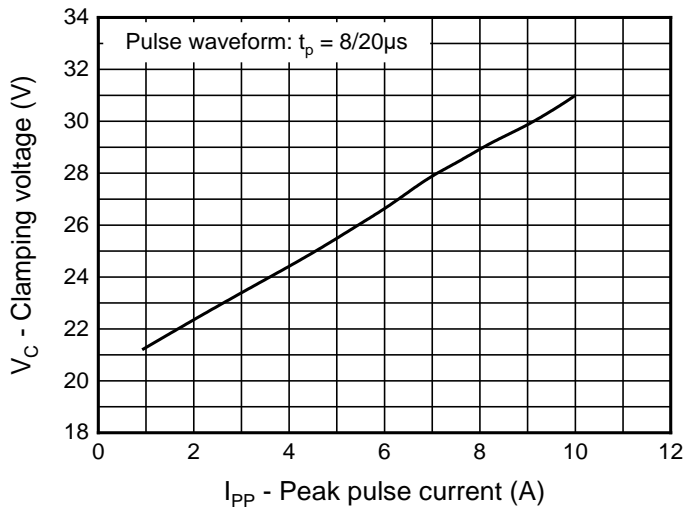

**I-V Curve**

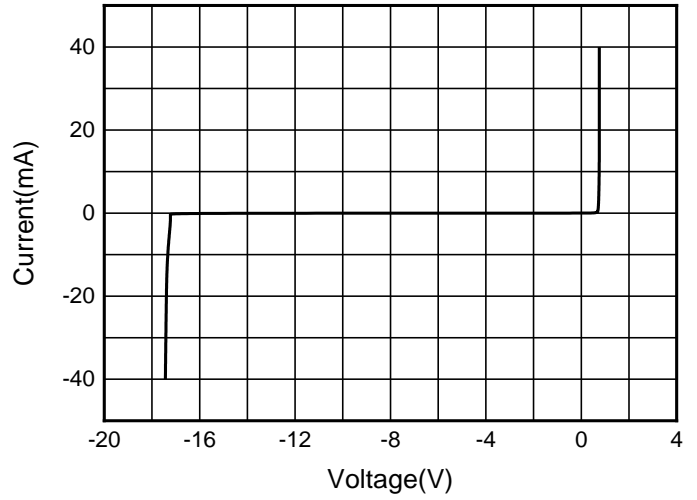

**Peak pulse power vs. Pulse time**

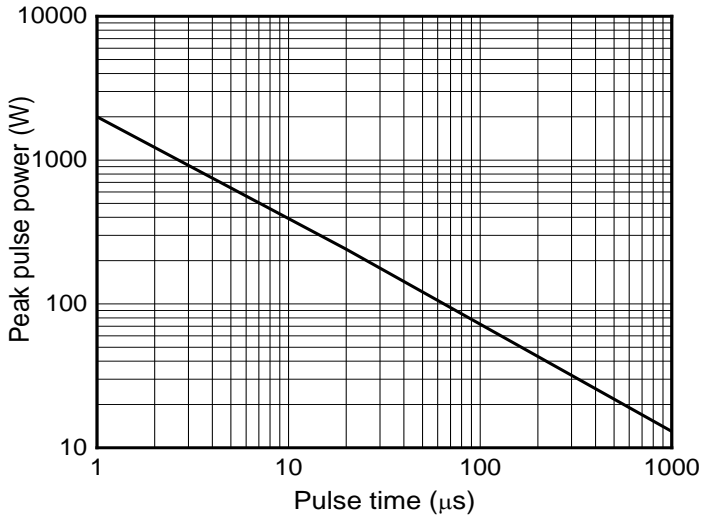

**Power derating vs. Ambient temperature**

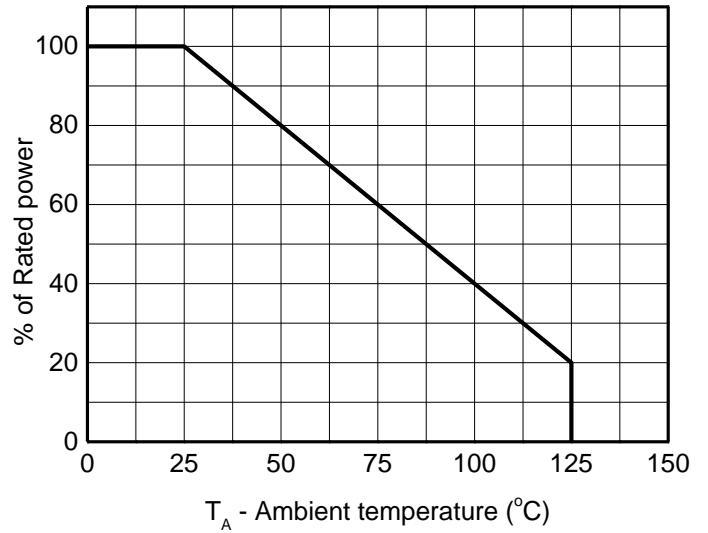

## SOD-323 Package Outline Dimensions

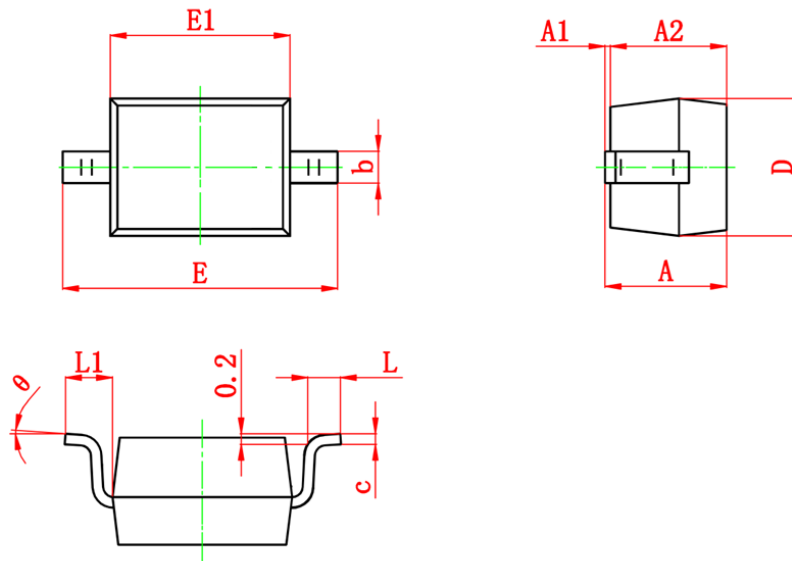

Symbol	Dimensions In Millimeters		Dimensions In Inches	
	Min.	Max.	Min.	Max.
A	1.150MAX		0.045MAX	
A1	0.000	0.100	0.000	0.004
A2	0.800	0.900	0.031	0.035
b	0.250	0.400	0.010	0.016
c	0.080	0.180	0.003	0.007
D	1.200	1.400	0.047	0.055
E	2.500	2.800	0.098	0.110
E1	1.600	1.800	0.063	0.071
L	0.200	0.450	0.008	0.018
L1	0.475REF		0.019REF	
θ	0°	8°	0°	8°